

HITACHI
Inspire the Next

www.hitachiconsumer.com.my

Auto Intelligence

Inverter Washing Machine



Hitachi Sales (Malaysia) Sdn Berhad.
Customer Careline: 1 800 88 1122 Email: marketing.hsm.tf@hitachi.com
Monday to Friday: 9.00am to 9.45pm



AUTO SELF CLEAN – THE TUB STAIN FIGHTER

As you use your washing machine day after day, dirt, such as sebum, detergent residue, bacteria, germs and black mould spores will gradually accumulate in the tub. If left uncleaned, the dirt build-up will eventually stain the tub and become harder to remove over time. Consequently, the dirt and stains will affect clothing quality and cleanliness.

Now, with Hitachi's Auto Self Clean, it will remove 99% of germs^{*1} and prevent mould growth^{*2} in each washing. When doing your laundry, switch the Auto Self Clean setting "ON"^{*3} and it automatically washes away dirt from the outside and bottom of the stainless steel tub, as well as the inside and bottom of the outer tub.

Introducing the new Made In Japan Front Load Big Drum Washing Machine with ground-breaking technologies developed exclusively by Hitachi. The multi-functional eco washing machine combines washer, dryer and steam iron into one intelligent system to bring unparalleled convenience to sophisticated users. It also features the original Auto Self Clean "The Tub Stain Fighter" that automatically washes the tub after use, alongside the innovative Wind Iron to effectively minimise time spent on ironing.

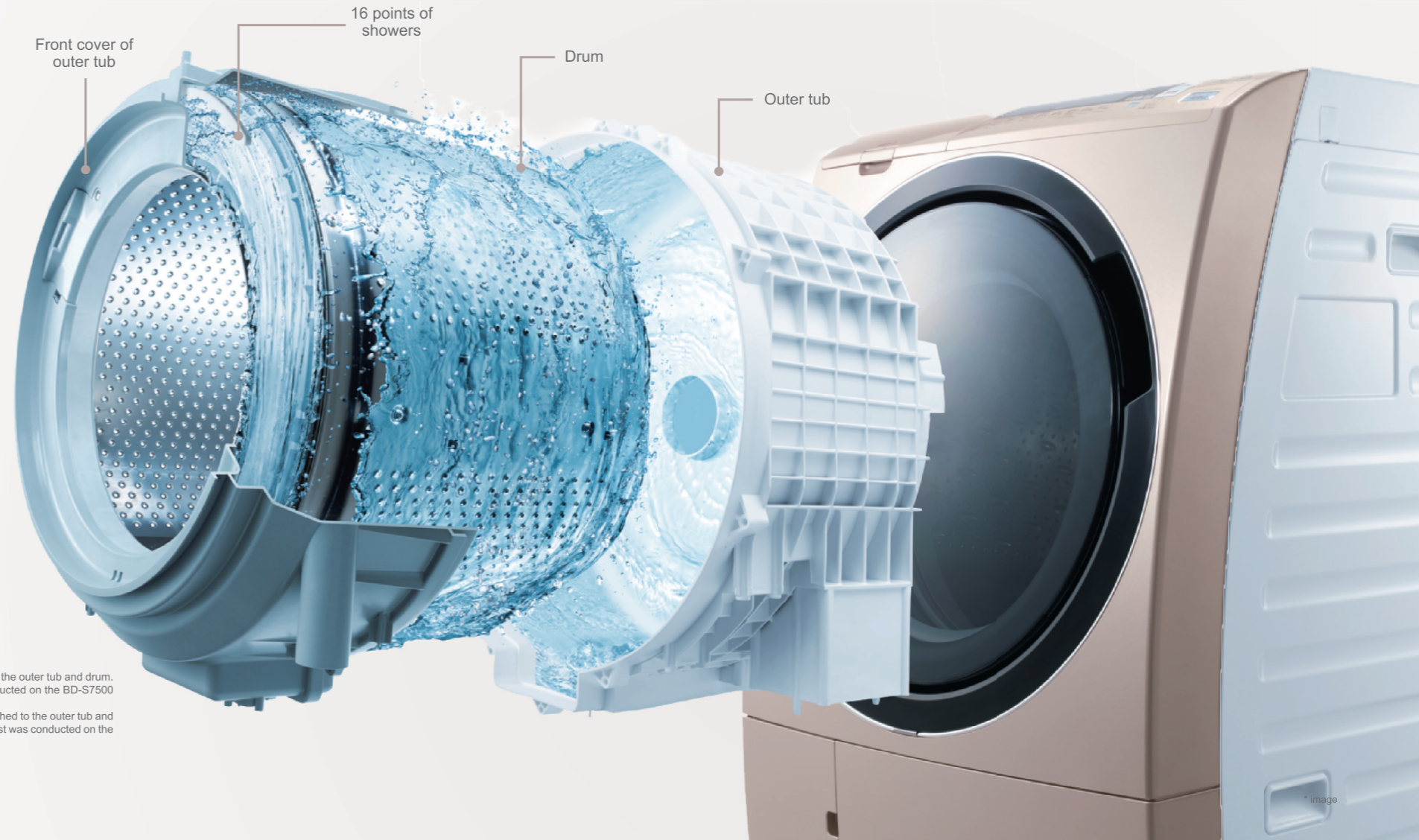

^{*1} Tested by Kitasato Research Centre for Environmental Science. • Test method: Measurement of the reduction rate of germs smeared on plates that are attached to the outer tub and drum. • Means for germs removal: Use of the Auto Self Clean function. • Test objects: Outer tub and drum. • Test result: Germs reduction rate: 99%. • The test was conducted on the BD-S7500 (base model of the BD-S5500 for Japan) in Japan, using water, soiled laundry and detergent of Japan.

^{*2} Tested by Kitasato Research Centre for Environmental Science. • Test method: Confirmation of the inhibitory effect of mould growth on medium plates that are attached to the outer tub and drum. • Means for preventing mould growth: Use of the Auto Self Clean function. • Test objects: Outer tub and drum. • Test result: Mould reduction rate: 99%. • The test was conducted on the BD-S7500 (base model of the BD-S5500 for Japan) in Japan, using water, soiled laundry and detergent of Japan.

^{*3} The setting is switched off at the time of shipment from the factory. • Once switched on, Auto Self Clean operates every time you do your laundry.

REMOVE GERMS*4 AND PREVENT MOULD GROWTH*5 IN EACH WASHING

*5
99%
MOULD & BACTERIA
REDUCTION
AUTO
SELF
CLEAN

THESE PLACES GET DIRTY EASILY*6

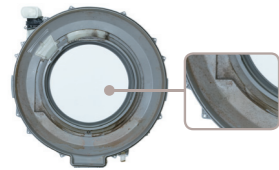

Front cover of the outer tub

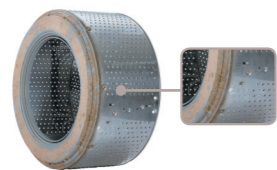

Drum (Inner tub)

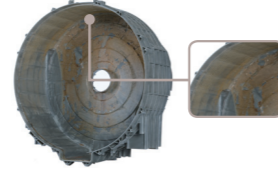

Bottom of outer tub and side

TUB WILL ACCUMULATE BLACK MOULDS IF NOT CLEANED OVERTIME

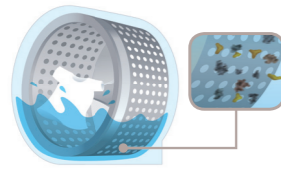

During washing

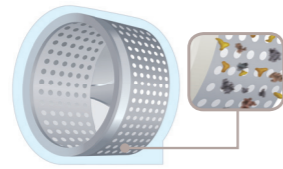

After washing

* image

During washing, dirt gradually accumulates in the tub. After washing, dirt becomes attached to the tub and will be harder to remove.

MECHANISMS THAT REMOVE DIRT EFFECTIVELY

1. SHOWER

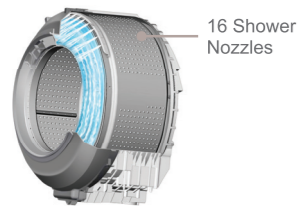

16 Shower Nozzles

* image

2. STRONG WATER FLOW

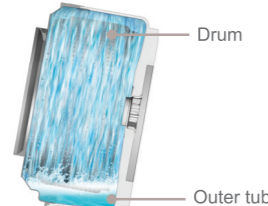

Drum

Outer tub

* image

3. NEW SPIN HOLE LAYOUT

Spin Hole layout of the drum realigned to allow water to flow out and shower the outer tub effectively.

16 Shower Nozzles release clean water through High Speed Spinning to wash the front portion of the drum. Strong water flow collected from the bottom of the tub then washes the outer tub of the drum. In addition, New Spin Hole layout on the drum allows water from the inside of the drum to flow into the outer tub of the drum.

*4 Tested by Kitasato Research Centre for Environmental Science. • Test method: Measurement of the reduction rate of germs smeared on plates that are attached to the outer tub and drum. • Means for germs removal: Use of the Auto Self Clean function. • Test objects: Outer tub and drum. • Test result: Germs reduction rate: 99%.
 • The test was conducted on the BD-S7500 (base model of the BD-S5500 for Japan) in Japan, using water, soiled laundry and detergent of Japan.
 *5 Tested by Kitasato Research Center for Environmental Science. • Test method: Confirmation of the inhibitory effect of mould growth on medium plates that are attached to the outer tub and drum. • Means for preventing mould growth: Use of the Auto Self Clean function. • Test objects: Outer tub and drum. • Test result: Mould reduction rate: 99%.
 • The test was conducted on the BD-S7500 (base model of the BD-S5500 for Japan) in Japan, using water, soiled laundry and detergent of Japan.
 *6 Tested by Hitachi using a Hitachi washing machine. • The dirt conditions vary according to usage patterns.

DIRT-RESISTANT DRAIN HOSE

The newly designed drain hose comes with a smooth inner surface without any pleats and is further treated with antibacterial agent*7. Dirt will find it difficult to remain in the hose as compared to conventional hoses. Combined with high-speed wind generated by the Wind Iron, water is swiftly discarded separately through the new drain hose.

Dirt inside the drain hose



Hidden dirt inside the hose*

*Hitachi washer-dryer. The dirt conditions vary according to usage patterns.

Conventional hose

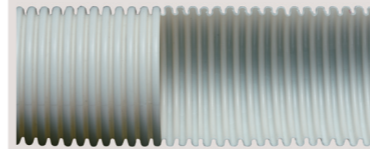

Due to the pleat-shaped drain hose, water and dirt get trapped easily.

Flat inner wall hose

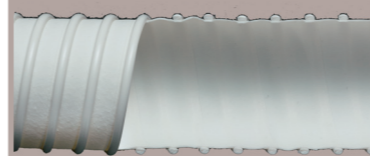

Water and dirt are less likely to remain inside the hose.

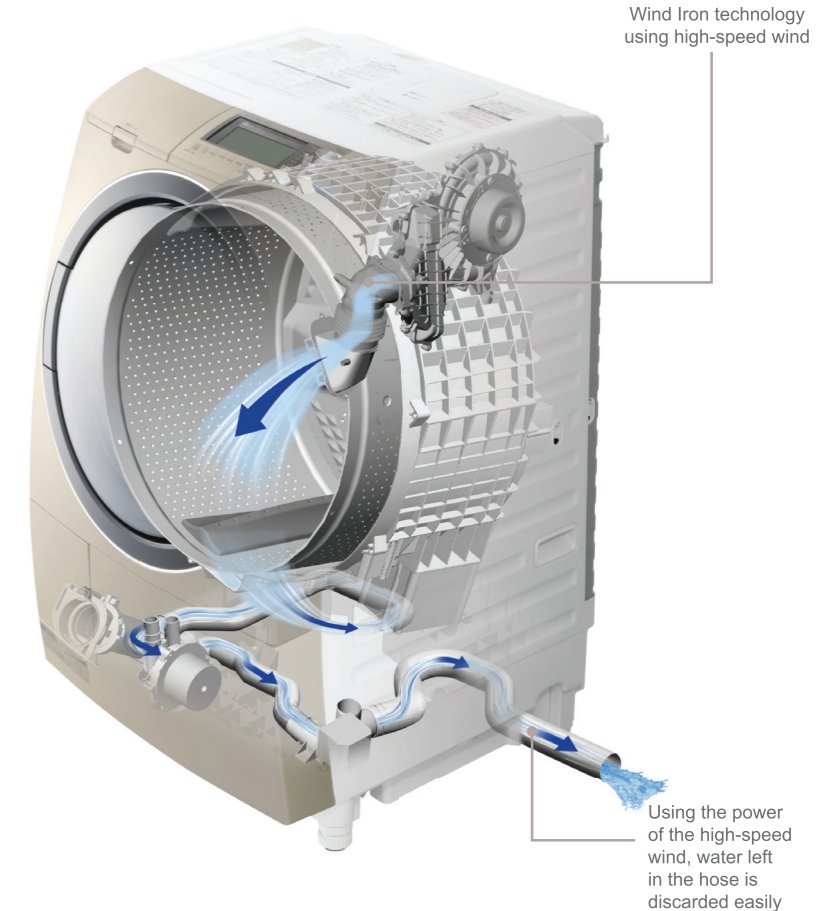

*7 Test institution: Boken Quality Evaluation Institute. • Test method: JIS Z 2801 (Film adhesion method). • Means for antibacterial finish: Blending an antibacterial agent into resin material. • Test object: Drain hose. • Test result: Antibacterial activity value: 2.0 or greater (considered to be antibacterial when this value is 2.0 or greater). • The test was conducted on the BD-S7500 (base model of the BD-S5500 for Japan) in Japan.

WIND IRON

Hitachi's original Wind Iron technology smooths out wrinkles after washing and drying, so that you can wear clothes directly out of the drum and save time on ironing. The widened drum allows clothes to move freely when drying to prevent wrinkling, while the high-speed airflow of about 300km/h generated by the Jet Fan Motor stretches out the remaining wrinkles.



| (1.0kg) | (3.5kg) | (6.0kg) |
|--|--|--|
| Wash and wear every day without ironing hassle | Load a family of 4's entire day laundry easily and wear straight after washing | Wash bigger loads such as bedsheets all at once. Wrinkling is reduced even without operating this function |
| Blouse Cotton 55%, Polyester 45% | Blouse Cotton 55%, Polyester 45% | Blouse Cotton 55%, Polyester 45% |
| Casual blouse Cotton 100% | Casual blouse Cotton 100% | Casual blouse Cotton 100% |
| T-shirt Cotton 100% | T-shirt Cotton 100% | T-shirt Cotton 100% |
| Trousers Cotton 75%, Polyester 25% | Trousers Cotton 75%, Polyester 25% | Trousers Cotton 75%, Polyester 25% |
| Handkerchief Cotton 100% | Handkerchief Cotton 100% | Handkerchief Cotton 100% |

*The Wind Iron operation reduces wrinkles with varying results depending on the wash load, the material of the items, and the types of items that are dried together. Wrinkles cannot be eliminated completely. If you have only the drying operation as a finish of dry wash laundry and half-dry laundry. It is not possible to eliminate wrinkles.

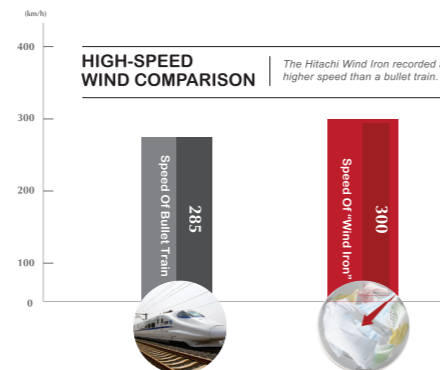

HEAT RECYCLE DRYING

When the [POWER SAVE] or [POWER SAVE STATIC DRY] programme is selected, heat generated by the Jet Fan Motor is reused to power the high speed airflow while simultaneously used as hot air in the dryer. This process is known as Heat Recycle Drying. During Heat Recycle Drying, heat generated from the main motor is transferred into the drum to raise temperature. Electricity usage is reduced.

Recycled from the Main Motor

Heat generated from the Main Motor is transferred into the drum to raise temperature.

Recycled from the Jet Fan

In addition to heat from the heater, compressed heat from the Jet Fan which generates high-speed airflow, and heat from the Jet Fan Motor are used as hot air during drying.

Recycled heat from Eco Vent

Air warmed by the main motor and heater enters the Eco Vent (open-close type inlet), which is set along the drying pipeline. The warm air is then used for drying.



WIDE CIRCULATION SHOWER

Detergent water prepared by dissolving detergent at the 2-way circulation pump is sprayed from the top of the wide drum with a jet flow. This new pump circulation enables a large amount of detergent water to be sprayed evenly across the tub, ensuring that laundry is thoroughly cleaned.

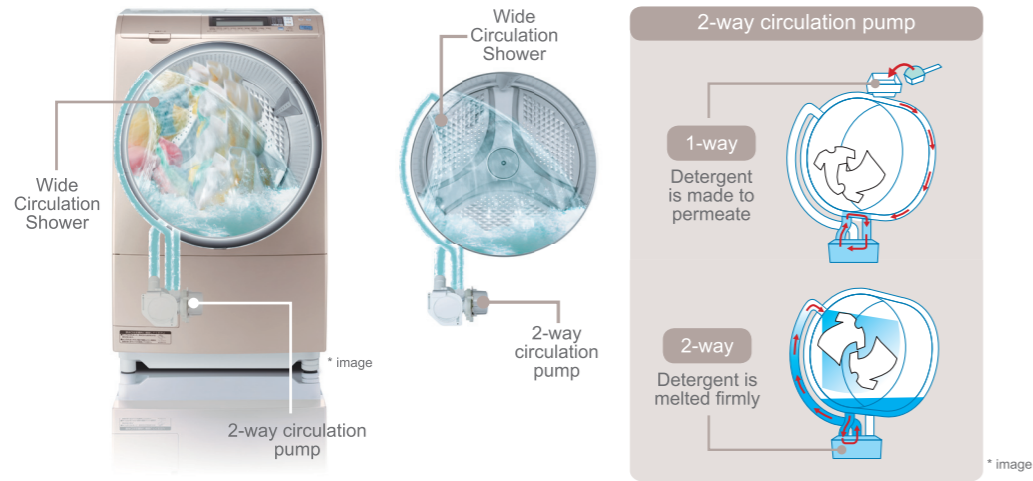

3D SENSOR CONTROL WASH

To maximise the beat washing effect, the drum rotation speed and amount of water used are automatically adjusted based on the type and laundry load size detected by the sensors.

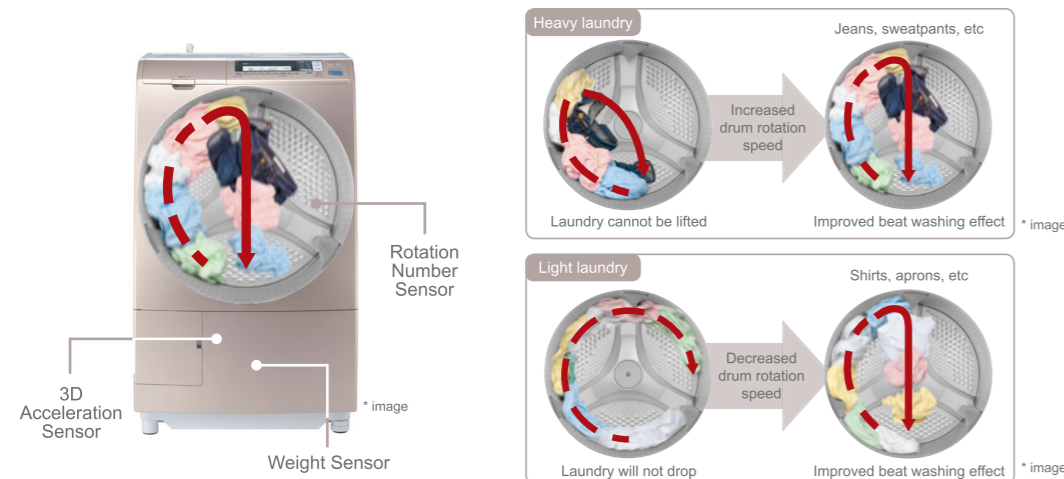

STEAM IRON

The washing machine also comes equipped with the convenient Steam Iron feature that carries the dual-function of reducing wrinkles and odour at the same time. The Steam Iron can smooth out up to 1kg of dry clothes that have been worn, hung or kept for a long period in one load. Used together with the Wind Iron, visibility of wrinkles will be reduced. Operating on warm Steam Spray temperature with added deodorising effect, you can now wear your clothes straight from the washer.

300km/h High-Speed Wind



You can smooth out wrinkles of clothes which are hung, worn, or kept in closet*.

Steam Spray

| Desired operation | Program | Load of clothes (guide) | Example of clothes |
|---|------------|-------------------------|----------------------------------|
| Smoothing out wrinkles of dry clothes with Steam Iron | 15 minutes | 0.5kg | Casual Shirt (1) Blouse (1) |
| | 30 minutes | 1.0kg | Casual Shirts (2) Blouses (2) |

- * The smoothing effect varies depending on the load size and type of clothes. Wrinkles will be reduced but not completely removed.
- Wrinkles are harder to remove when loading more than 1kg of clothes.
 - There is no effect to as pressed with an iron.



BIG DRUM

Designed with a massive drum depth of approximately 39cm that can easily fit up to approximately 75 litres capacity of laundry, all your clothes can be washed at once to save time and electricity consumption.



HIGH-SPEED SPIN

The Big Drum rotates at a very high speed of maximum 1,875 r/min so that the centrifugal coefficient is high, which enables thorough spin-drying in the shortest time.

ENERGY SAVING DIRECT DRIVE INVERTER

Advanced DD (Direct Drive) Inverter operation enables a further reduction in noise and energy demands. The use of a Direct Current Brushless Motor produces high torque while maintaining whisper-quiet operation.

HIGH-DAMPING HYDRAULIC SUSPENSION

Two oil pressure suspensions, just like the system used in automobiles, support the drum and flexibly change the degree of damping to match the amplitude of vibrations to dramatically reduce them. At the start of spin-drying when vibrations are large, thorough damping assures firm support for the drum. When the drum is spinning fast and vibrations are small, soft damping prevents the transmission of vibrations and provides gentle support for smooth operation. Support from two suspensions also minimises transmission of vibrations to the washing machine casing.



4-PLY LIQUID LOAD BALANCER

If the items in the drum become unevenly balanced, liquid inside the 4-Ply chamber moves to the opposite side of the load to offset the imbalance. Making the drum better balanced in this way will dramatically reduce vibrations.

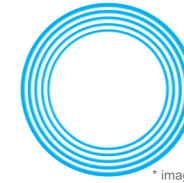

When the load is balanced, liquid inside the 4-Ply chamber is moved away from the center of rotation by centrifugal force.



When the load is unevenly balanced, the liquid moves to the opposite side of the load to eliminate the imbalance.

3D ACCELERATION SENSOR

The 3D Acceleration Sensor accurately detects the overall vibration of the drum. This technology maintains optimum vibration control during drying time and virtually eliminates the occurrence of operational stoppage due to load imbalance.

USER-FRIENDLY FEATURES



Detergent inlet for top loading and easy lid removal.



Large white LCD panel for easy reading.



Door handle that can be easily opened with one hand.



Dry filter that is easy to remove.

NANO TITANIUM



Nano Titanium technology allows clothes to be freshened without the use of water. The Nano Titanium Filter deodorises while hot air sterilises your laundry by eliminating bacteria. This function is ideal for items such as suits, hats and cushions that will lose their shapes if washed frequently, and bags that cannot be washed with water.



For suits that cannot be washed with water



For uniforms worn daily

SPECIFICATIONS

| MODEL | | BD-S5500 | BD-W1500 |
|--------------------------|---|--------------------------------------|--------------------------------|
| WASHING CAPACITY | | 10.5 kg | 10.5 kg |
| DRYING CAPACITY | | 7 kg | 7 kg |
| DRUM ROTATION SPEED | WASHING | 10 – 41 r/min | 10 – 35 r/min |
| | SPINNING | 950 (1.875) (High Speed Spinning) | 950 (1.000) (Warm Spinning) |
| | DRYING | 30 – 65 r/min | 45 – 100 r/min |
| WATER CONSUMPTION | WASHING (FUZZY) PROGRAM WITH AUTO SELF CLEAN | 103 litres | - |
| | WASHING (FUZZY) PROGRAM WITHOUT AUTO SELF CLEAN | 94 litres | 80 litres |
| WASHING TECHNOLOGY | BIG DRUM DIAMETER | Approximately 53 cm | Approximately 60cm |
| | 3D CONTROL SENSOR | • | • |
| | SPRAYED RINSE | • | - |
| | SHOWER BY 2-WAY CIRCULATION PUMP | • | - |
| DRYING TECHNOLOGY | HEAT RECYCLE | • | - |
| | WIND IRON | • | - |
| ENERGY SAVING TECHNOLOGY | 2-WAY DEHUMIDIFY (AIR / WATER COOLING) | • | • (Water cooling only) |
| | DIRECT DRIVE INVERTER MOTOR | • | • |
| LOW VIBRATION TECHNOLOGY | HIGH-DAMPING HYDRAULIC SUSPENSION | • | • |
| | 4-PLY LIQUID LOAD BALANCER | • | - |
| | 5-PLY LIQUID LOAD BALANCER | - | • |
| | 3D ACCELERATION SENSOR | • | • |
| CLEANING FEATURE | NANO TITANIUM FILTER | • | • |
| | AUTO SELF CLEAN | • | - |
| CONVENIENT FEATURE | STEAM IRON | • | - |
| | PRESET WASHING TIMER | 3-12 hours | 3-12 hours |
| | STAINLESS STEEL DRUM | • | • |
| | CROSS CUT TUB | • | • |
| | FLAT INNER WALL HOSE | • | - |
| | FINISH WARNING SOUND | • | • |
| | ADJUSTABLE LEG | • | • |
| | DOOR LOCK | • | • |
| POWER SOURCE | | 220 – 240 V | 220-240V |
| | | 50 Hz | 50Hz |

| MODEL | | BD-S5500 | BD-W1500 |
|-------------|--|----------------|-----------------|
| RATED POWER | WASHING | 500 W | 500 W |
| | DRYING | 1,350 W | 1,350 W |
| DIMENSIONS | W (WITH DRAIN HOSE) | 630 mm | 735 mm |
| | W (WITHOUT DRAIN HOSE) | 600 mm | 695 mm |
| | H (WITH WATER INLET VALVE, DRY FILTER & DETERGENT CASE LID) | 1,180 mm | 1,037 mm |
| | H (WITHOUT WATER INLET VALVE, DRY FILTER & DETERGENT CASE LID) | 1,020 mm | 995 mm |
| | D (WITHOUT DRAIN HOSE) | 715 mm | 600 mm |
| NET WEIGHT | | 83 kg | About 80 kg |
| COLOUR | | CHAMPAGNE GOLD | PLATINUM SILVER |

BD-S5500

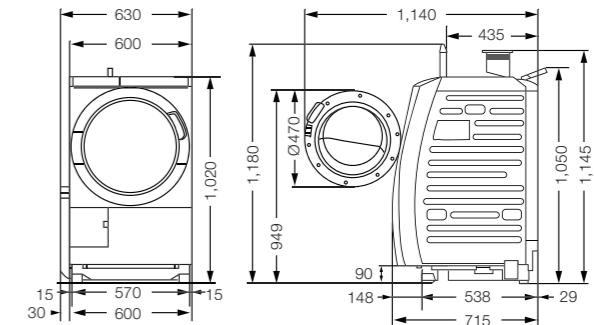

BD-W1500

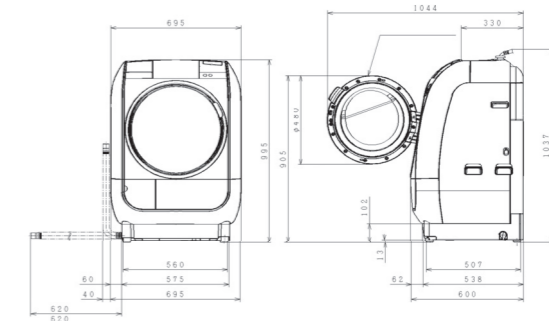

All specifications in content are subject to change without prior notice. Colour tone of actual product may differ from those shown in this catalogue.